

Electrolysis (A2)

Electrolysis is a process in which current is passed through an electrolyte of ionic compound either in solution or molten state. The electrolyte is then decomposed as solids or evolved as gases.

The conductors which connect the electrolyte with the applied voltage are called electrodes. The positive electrode is the anode, the negative electrode is the cathode.

During electrolysis,

At the cathode (- electrode):

- cations (+ve ions) travel to the cathode (-).
- reduction occurs at the cathode.
- cathode is connected to the -ve pole of the electricity supply.

At the anode (+ electrode):

- anions (-ve ions) travel to the anode (+).
- oxidation occurs at the anode.
- anode is connected to the +ve pole of the electricity supply.

Factors affecting selective discharge during electrolysis

1. Position of ions in the electrochemical series
2. Relative concentration of ions.
3. Nature of electrode.

Position of ions in the electrochemical series

a) At the cathode:

- In a mixture of cations, the cations of metal with the most positive E^\ominus are discharged first.
- E.g., consider a mixture of $Zn^{2+}(aq)$, $Cu^{2+}(aq)$, $Pb^{2+}(aq)$ and $Ag^+(aq)$ ions.
- The order of metal/metal ions in the electrochemical series:

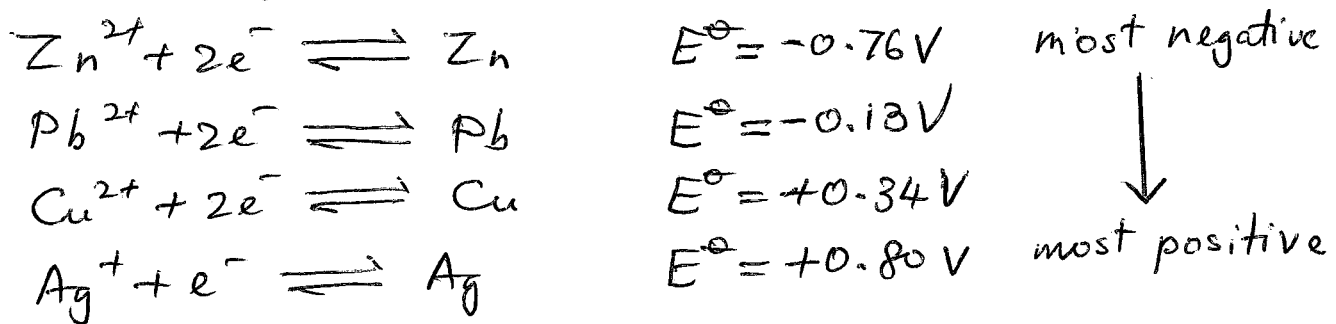

- When the mixture is electrolyzed, the Ag^+ are discharged first (most positive E^\ominus). After all the Ag^+ have been discharged, the Cu^{2+} will be discharged, followed by the Pb^{2+} ions. Finally the Zn^{2+} ions will be discharged.

b) At the anode

- In a mixture of anions, the anion with the most negative E^\ominus is discharged first. This anion is most easily oxidised.
- E.g., in a mixture of $\text{Cl}^-(\text{aq})$ and $\text{I}^-(\text{aq})$ ions the order of the ions in the redox series:

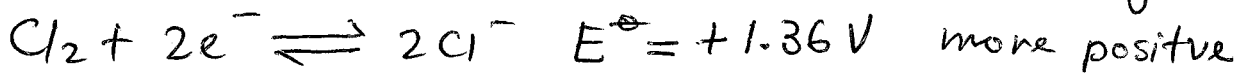
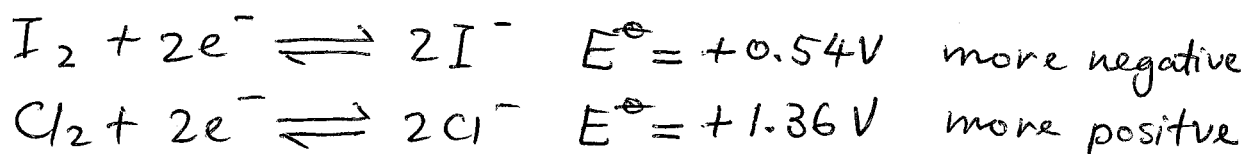

- When the mixture is electrolysed, the I^- ions are discharged first (more negative E^\ominus). After all the iodide ions have been discharged, the Cl^- ions will be discharged.

Relative concentration of ions

During electrolysis of dilute aqueous NaCl , concentration of Cl^- is low. Therefore OH^- ions get discharged at the anode and the O_2 gas produced.

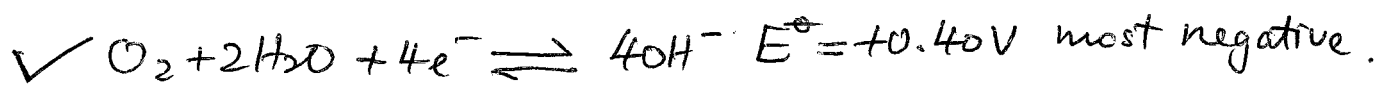

But during electrolysis of concentrated solution NaCl (brine), concentration of Cl^- ion is very high. Therefore Cl^- ions selectively get discharged at the anode and Cl_2 gas produced. Refer to Le Chatelier's principle, p.o.e. to direction of reducing $[\text{Cl}^-]$, Cl^- discharged to form Cl_2 .

Nature of electrode

When dilute sulfuric acid is electrolyzed, using graphite electrodes, OH^- ions are discharged at the anode. The product at the anode is O_2 gas.

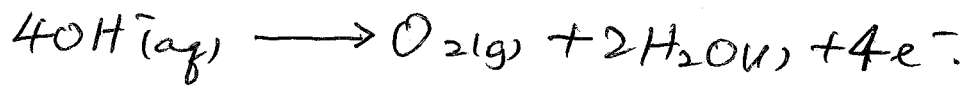

If the graphite electrodes are now replaced with copper electrodes, the copper anode dissolves:

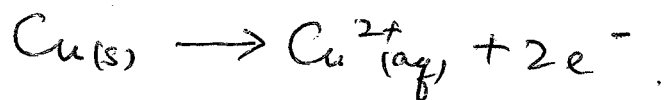

The solution gradually changes to blue colour due to the formation of CuSO_4 .

Quantitative Electrolysis

During electrolysis of salts of metals low in the electrochemical series eg. silver, copper, gold, the cathode reactions are:

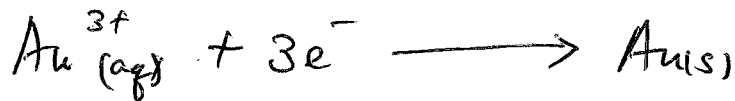
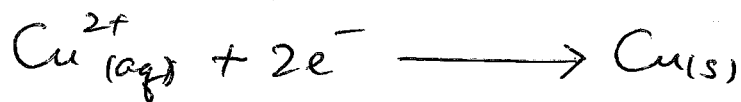
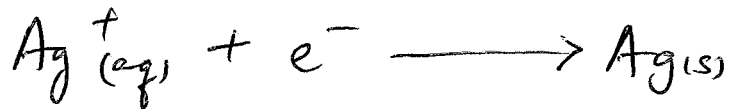

i.e.

1 mole of electrons discharge 1 mole Ag ions to give 1 mole Ag atoms

2 mole of electrons discharge 1 mole Cu ions to give 1 mole Cu atoms

3 mole of electrons discharge 1 mole Au ions to give 1 mole Au atoms

In General

$\text{No. of moles of element discharged} = \frac{\text{No. of moles of electrons}}{\text{No. of charges on one ion of element}}$
--

The Faraday and Avogadro's constant

It is possible to measure the charge on an electron.

Suppose we had 1 mole Ag ions and a current was passed which discharged all these ions to silver metal. Then the number of electrons that passes is L (Avogadro's constant). Let 'e' be the charge on one electron and F as the total charge required to discharge 1 mole of these ions.

$$\boxed{F = Le}$$

Faraday constant, $F = 96500 \text{ C mol}^{-1}$

Avogadro constant, $L = 6.02 \times 10^{23} \text{ mol}^{-1}$

charge on one electron, $e = 1.60 \times 10^{-19} \text{ coulombs}$

Finding Avogadro's constant by electrolysis

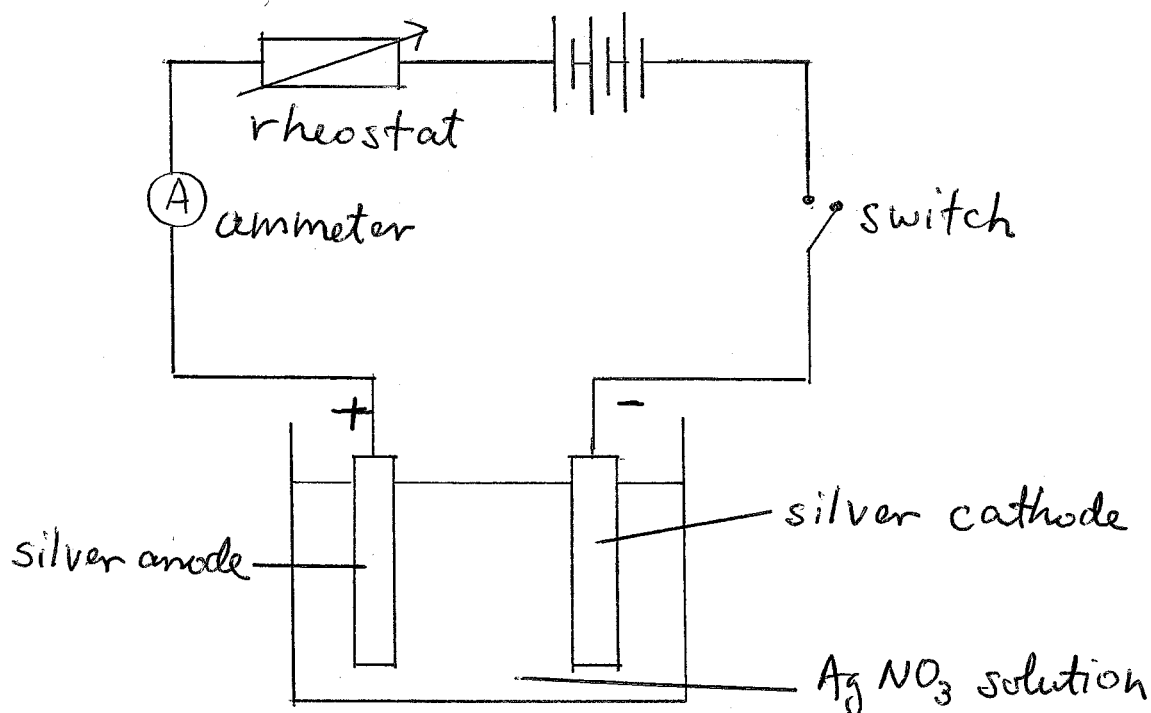

Set up the circuit above. Ammeter records current used, rheostat used to maintain current at constant value. Cathode is weighed (record the mass). Close the switch and start stopwatch. Allow current to pass for a reasonable length of time. Open switch, stop the watch, record current used and time (in seconds). Remove cathode, rinse and dry then reweigh. The mass of silver deposited by a known charge (amps \times seconds) is now known. If we know the charge on one electron, we can calculate the value for L .

From the readings of Ammeter and time recorded,

$$Q = I \times t$$

Q : quantity of charge produced, unit : coulomb, C

I : current (Ammeter reading), unit : ampere, A

t : time (stopwatch recordings), unit : second, s

It is found by experiment that 96500 coulombs of charge are required to discharge 1 mole of silver (108g); therefore 96500 coulombs must be the charge on one mole of electrons. The ratio 96500 C mol^{-1} is called the Faraday Constant.

Example.

A direct current of 10.0 mA flows for 4.00 hours through 3 cells in series. The cells contain solution of silver nitrate, copper(II) sulfate and gold(III) nitrate. Calculate the mass of deposited metal in each cell.

$$\begin{aligned} \text{The quantity of charge, } Q &= I \times t = 0.0100 \times 4.00 \times 60 \times 60 \\ &= 144 \text{ C} \end{aligned}$$

$$\text{no mole of electron} = \frac{144}{96500} \text{ mole}$$

$$\text{No mole Ag deposited} = \frac{144}{96500} \text{ mole}$$

$$\text{mass Ag deposited} = \frac{144}{96500} \times 108 = 0.161 \text{ g}$$

$$\text{No mole Cu deposited} = \frac{144}{2 \times 96500} \text{ mole}$$

$$\text{mass Cu deposited} = \frac{144}{2 \times 96500} \times 63.5 = 0.0474 \text{ g}$$

$$\text{No mole Au deposited} = \frac{144}{3 \times 96500} \text{ mole}$$

$$\text{mass Au deposited} = \frac{144}{3 \times 96500} \times 197 = 0.0980 \text{ g}$$

Exercise

A metal of $A_r = 27$ is deposited by electrolysis. If 0.176 g of the metal is deposited on the cathode when 0.15 A flows for 3.5 hours, what is the charge on the cations of this metal?

Answers

$$\text{The quantity of charge, } Q = I \times t = 0.15 \times 3.5 \times 60 \times 60 = 1,890 \text{ C}$$

$$\text{no mole of electron} = \frac{1890}{96500} \text{ mole}$$

$$\text{no mole of metal deposited} = \frac{0.176}{27} \text{ mole}$$

$$\text{charge on the cation} = \frac{\text{no mole of electrons}}{\text{no mole of metal deposited}}$$

$$= \frac{1890}{96500} \div \frac{0.176}{27}$$

$$= \frac{1890 \times 27}{96500 \times 0.176}$$

$$= 3$$

Example

When a current of 7.66 amps is passed for 1 hour, it is found that 30.83 g silver are deposited.

Calculate Avogadro constant.

Answers

$$\begin{aligned} \text{The quantity of charge, } Q &= I \times t = 7.66 \times 1 \times 60 \times 60 \\ &= 27,576 \text{ C} \end{aligned}$$

$$\text{no mole of Ag deposited} = \frac{30.83}{108} \text{ mole}$$

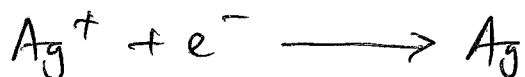

1 mol electrons required to produce 1 mol Ag metal

$$\begin{aligned} \text{charge of 1 mol of electrons, } F &= \frac{Q}{n(\text{Ag})} \\ &= \frac{27,576}{\left(\frac{30.83}{108}\right)} \text{ C} \end{aligned}$$

$$\text{charge of one electron, } e = 1.60 \times 10^{-19} \text{ C}$$

$$F = L \times e$$

$$\text{Avogadro's constant, } L = \frac{F}{e} = \frac{27576}{\left(\frac{30.83}{108}\right)} \div 1.60 \times 10^{-19}$$

$$= \frac{27576 \times 108}{30.83 \times 1.60 \times 10^{-19}}$$

$$= \underline{\underline{6.04 \times 10^{23} \text{ mol}^{-1}}}$$

Volume of gases formed during electrolysis

Solutions of salts high in electrochemical series evolve hydrogen gas at the cathode on electrolysis.

The cathode process is:

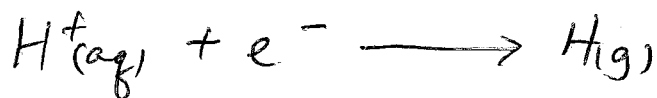

followed by



2 moles of electrons are needed to evolve 1 mole of hydrogen molecules; i.e. 2g. of hydrogen (the molar mass) or 22.4 dm^3 at s.t.p. (the molar volume).

At the anode, concentrated solutions of halides evolve the halogen, and other salts evolve oxygen.

When chlorine is evolved, the anode process is:



followed by.



2 moles of electrons are required for the evolution of 1 mole of chlorine molecules; i.e. 71.0g or 22.4 dm^3 at s.t.p.

When oxygen is evolved, the anode process is the discharge of hydroxide ions, derived from the water in the solution:

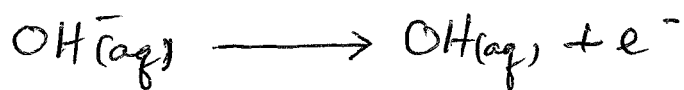

followed by

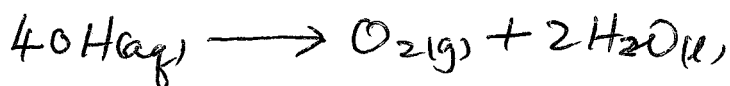

4 moles of electrons are required for the evolution of 1 mole of oxygen molecules; i.e. 32.0g or 22.4 dm³ at s.t.p.

Exercise.

Calculate the volumes of gases formed at the cathode and anode at s.t.p. when 0.0250 A of current are passed for 4.00 hours through a solution of sulfuric acid.

Answers

The quantity of charge, $Q = I \times t = 0.0250 \times 4 \times 60 \times 60 = 360 \text{ C}$

$$\text{no of mole of electron} = \frac{360}{96500} = 3.73 \times 10^{-3} \text{ mole}$$

At cathode,

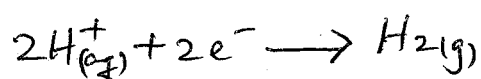

$$n(\text{H}_2) = \frac{3.73 \times 10^{-3}}{2} \text{ mole}$$

$$\begin{aligned} V(\text{H}_2) &= \frac{3.73 \times 10^{-3}}{2} \times 22.4 \\ &= \underline{\underline{4.18 \times 10^{-2} \text{ dm}^3}} \end{aligned}$$

At anode,

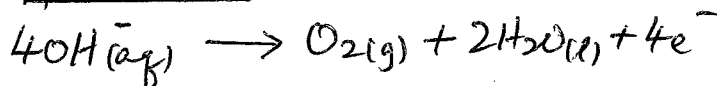

$$n(\text{O}_2) = \frac{3.73 \times 10^{-3}}{4} \text{ mole}$$

$$\begin{aligned} V(\text{O}_2) &= \frac{3.73 \times 10^{-3}}{4} \times 22.4 \\ &= \underline{\underline{2.09 \times 10^{-2} \text{ dm}^3}} \end{aligned}$$